

Appendix B: Traffic Counts

Site: 1
Survey Location: Cnr Princes Hwy & Clyde Rd, Batemans Bay
Date: 18th March, 2010

Count Period

AM Period : 11:00 - 1:00pm

PM Period : 3:00 - 5:00pm

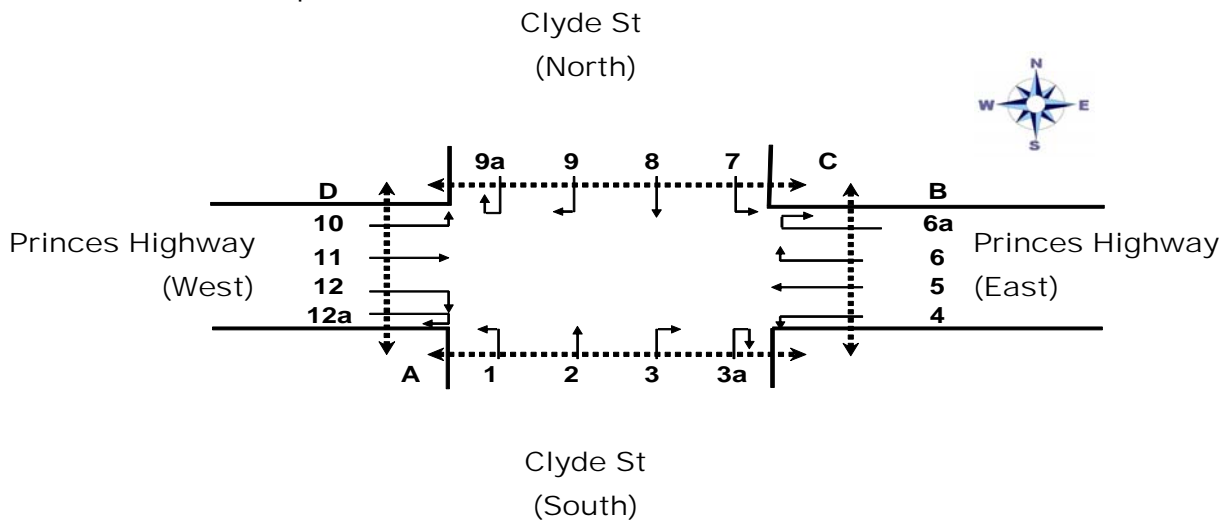

Time Interval		Movements														Hourly Total		
		1	2	3	3a	4	5	6	6a	7	8	9	9a	10	11		12	12a
11:00	11:15	5	0	0	0	49	99	1	0	3	1	4	0	6	123	4	0	
11:15	11:30	11	1	0	2	32	74	3	0	5	4	2	0	7	128	3	0	
11:30	11:45	13	0	0	0	44	120	1	0	3	1	0	0	3	153	7	0	
11:45	12:00	18	0	0	0	38	93	2	0	3	3	1	0	5	140	4	0	1219
12:00	12:15	18	0	0	0	28	85	4	0	3	3	8	0	6	130	2	0	1211
12:15	12:30	14	0	0	0	36	87	2	0	3	3	4	0	4	130	4	0	1226
12:30	12:45	10	0	0	0	33	103	0	0	2	2	3	0	1	129	2	0	1166
12:45	1:00	11	1	0	2	34	104	1	0	6	2	3	0	6	152	2	0	1183
Peak Period: 11:30AM-12:30 PM		63	0	0	0	146	385	9	0	12	10	13	0	18	553	17	0	

Time Interval		Movements														Hourly Total		
		1	2	3	3a	4	5	6	6a	7	8	9	9a	10	11		12	12a
3:00	3:15	11	1	0	1	40	101	2	0	3	3	1	0	3	173	3	0	
3:15	3:30	16	1	0	0	57	137	0	0	4	3	2	0	8	200	4	0	
3:30	3:45	8	0	1	1	34	76	2	0	2	0	1	0	5	172	5	0	
3:45	4:00	12	0	2	0	41	113	5	0	3	1	4	0	7	154	5	0	1428
4:00	4:15	14	0	0	0	43	131	1	0	1	4	3	0	7	203	4	0	1497
4:15	4:30	11	0	4	1	32	97	1	0	2	3	3	0	7	158	5	0	1389
4:30	4:45	16	0	0	1	37	109	3	0	3	1	0	0	3	207	5	0	1467
4:45	5:00	12	0	0	0	43	89	2	0	4	1	3	0	11	184	4	0	1473
Peak Period: 3:15-4:15 PM		50	1	3	1	175	457	8	0	10	8	10	0	27	729	18	0	

Site: 2
Survey Location: Perry St & North St, Batemans Bay
Date: 18th March, 2010

Count Period

AM Period : 11:00 - 1:00pm

PM Period : 3:00 - 5:00pm

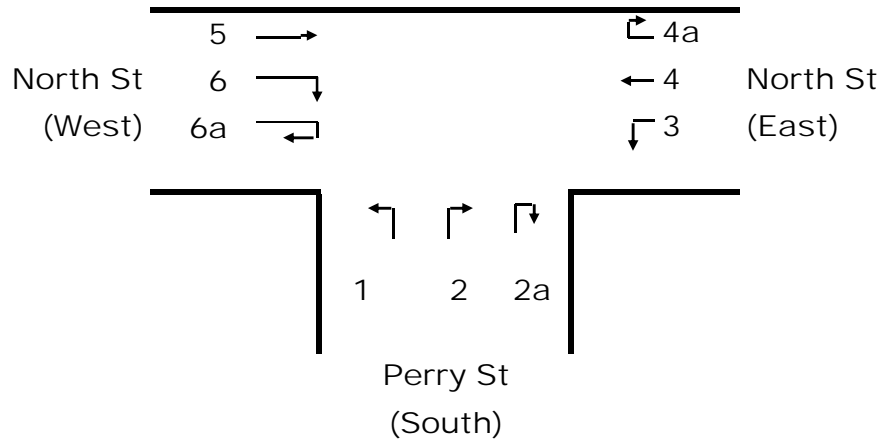

Time Interval		Movements									Hourly Total
		1	2	2a	3	4	4a	5	6	6a	
11.00am - 1.00am											
11:00	11:15	48	36	0	11	10	0	18	27	0	
11:15	11:30	51	35	1	9	8	0	23	18	0	
11:30	11:45	61	28	1	4	11	0	20	32	1	
11:45	12:00	47	22	1	8	7	0	14	31	0	583
12:00	12:15	61	34	0	1	4	0	20	22	0	575
12:15	12:30	65	36	0	9	12	0	22	17	0	591
12:30	12:45	45	45	2	6	10	0	18	22	0	581
12:45	1:00	42	40	0	3	8	0	23	19	1	587
Peak Period: 11:30AM-12:30 PM		234	120	2	22	34	0	76	102	1	

Time Interval		Movements									Hourly Total
		1	2	2a	3	4	4a	5	6	6a	
3:00pm - 5:00pm											
3:00	3:15	56	33	1	6	20	0	22	25	0	
3:15	3:30	69	35	0	7	8	0	13	29	1	
3:30	3:45	74	35	0	4	12	0	15	25	0	
3:45	4:00	56	31	0	9	11	0	21	34	0	652
4:00	4:15	60	51	0	6	8	0	19	27	0	660
4:15	4:30	57	39	0	14	9	0	15	24	0	656
4:30	4:45	71	43	0	6	16	0	13	29	0	669
4:45	5:00	72	34	0	5	12	0	16	33	0	679
Peak Period: 4:00PM-5:00 PM		260	167	0	31	45	0	63	113	0	

Site: 3
Survey Location: Clyde St & North St, Batemans Bay
Date: 18th March, 2010

Count Period

AM Period : 11:00 - 1:00pm

PM Period : 3:00 - 5:00pm

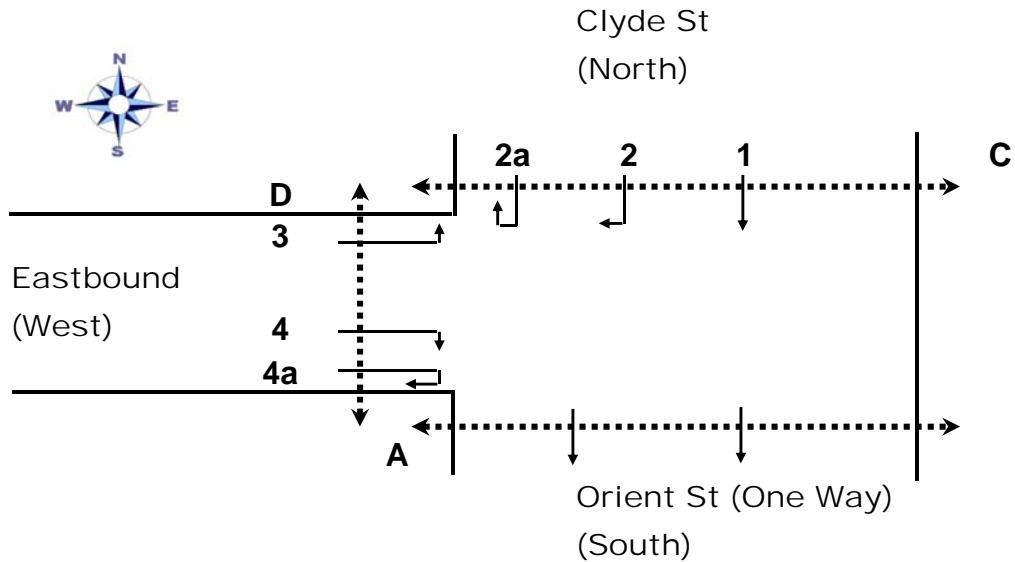

Time Interval		Movements						Hourly Total
		1	2	2a	3	4	4a	
11.00am - 1.00pm								
11:00	11:15	46	15	1	12	29	1	
11:15	11:30	47	18	1	11	30	0	
11:30	11:45	49	11	1	5	49	3	
11:45	12:00	48	14	0	8	38	1	438
12:00	12:15	20	6	0	6	29	1	396
12:15	12:30	32	17	1	16	41	3	399
12:30	12:45	35	14	1	15	34	2	382
12:45	1:00	39	15	0	17	56	0	400
Peak Period: 11:00AM-12:00 PM		190	58	3	36	146	5	

Time Interval		Movements						Hourly Total
		1	2	2a	3	4	4a	
3:00pm - 5:00pm								
3:00	3:15	48	21	0	14	44	1	
3:15	3:30	50	11	0	10	40	0	
3:30	3:45	49	15	0	9	33	3	
3:45	4:00	42	10	0	7	38	3	448
4:00	4:15	49	14	0	18	37	5	443
4:15	4:30	38	19	0	11	40	2	442
4:30	4:45	45	13	0	10	41	4	446
4:45	5:00	43	17	0	14	33	1	454
Peak Period: 4:00PM-5:00 PM		175	63	0	53	151	12	

Site: 4
Survey Location: Orient St & Beach Rd, Batemans Bay
Date: 18th March, 2010

Count Period

AM Period : 11:00 - 1:00pm

PM Period : 3:00 - 5:00pm

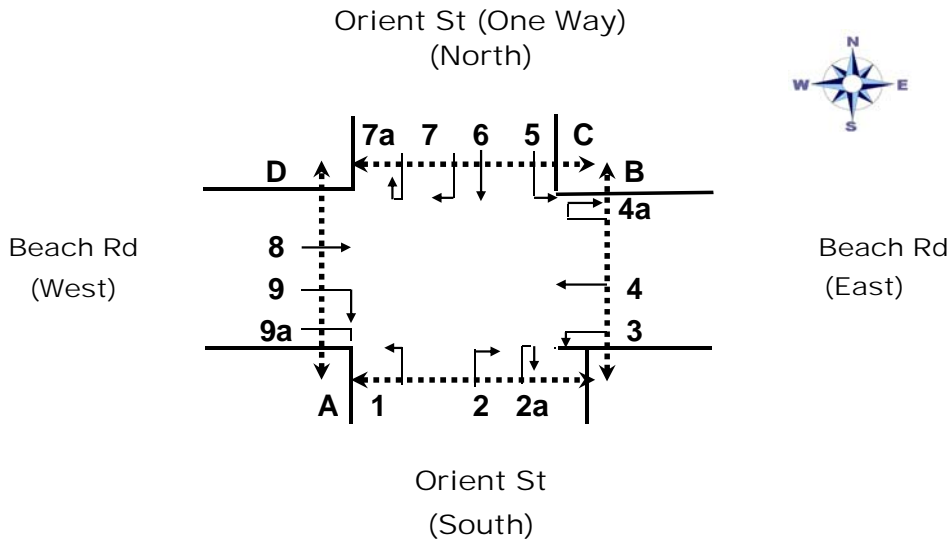

Time Interval		Movements												Pedestrian				Hourly Total	
		1	2	2a	3	4	4a	5	6	7	7a	8	9	9a	A	B	C		D
11:00	11:15	0	0	0	0	0	0	0	0	0	0	0	0	0	0	0	0	0	
11:15	11:30	17	6	0	6	53	0	34	33	11	0	71	12	0	5	5	8	36	
11:30	11:45	24	6	0	5	112	0	34	37	10	0	109	11	0	26	4	0	13	
11:45	12:00	45	10	0	10	120	0	33	24	16	0	62	7	0	25	0	4	12	1056
12:00	12:15	29	17	0	9	120	0	32	22	1	0	93	15	0	15	3	13	34	1459
12:15	12:30	19	14	0	9	99	0	24	19	12	0	83	5	0	19	4	3	24	1496
12:30	12:45	34	16	0	7	122	0	33	19	0	0	67	16	0	17	3	15	31	1485
12:45	1:00	28	7	0	8	117	0	34	29	26	0	65	10	0	27	4	8	35	1515
Peak Period: 12:00PM-1:00 PM		110	54	0	33	458	0	123	89	39	0	308	46	0	78	14	39	124	

Time Interval		Movements												Pedestrian				Hourly Total	
		1	2	2a	3	4	4a	5	6	7	7a	8	9	9a	A	B	C		D
3:00	3:15	36	10	0	6	144	0	36	25	17	0	95	13	0	17	2	5	13	
3:15	3:30	34	12	0	8	180	0	48	31	15	0	102	15	0	14	1	6	25	
3:30	3:45	37	17	0	1	135	0	41	19	25	0	90	12	0	7	0	3	18	
3:45	4:00	33	10	0	8	97	0	39	23	11	0	83	11	0	6	0	5	13	1654
4:00	4:15	27	11	0	7	132	0	41	27	9	0	95	7	0	8	1	8	23	1631
4:15	4:30	21	8	0	6	122	0	29	14	7	0	108	7	0	0	0	0	16	1478
4:30	4:45	27	17	0	4	156	0	60	25	13	0	122	17	0	11	3	3	19	1550
4:45	5:00	50	8	0	2	91	0	33	12	15	0	86	5	0	3	0	0	9	1525
Peak Period: 3:00PM-4:00 PM		140	49	0	23	556	0	164	98	68	0	370	51	0	44	3	19	69	

Site: 5
Survey Location: Cnr Perry St & Beach Rd, Batemans Bay
Date: 18th March, 2010

Count Period

AM Period : 11:00 - 1:00pm
PM Period : 3:00 - 5:00pm

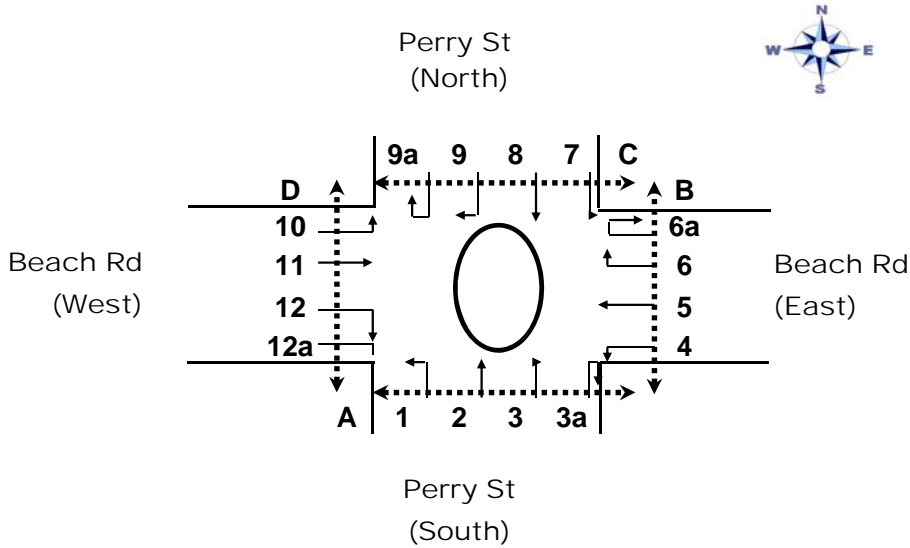

Time Interval		Movements															Hourly Total
11.00am - 1.00pm		1	2	3	3a	4	5	6	6a	7	8	9	9a	10	11	12	
11:00	11:15	2	3	3	0	12	52	131	1	45	4	16	0	17	26	27	0
11:15	11:30	0	5	1	0	9	49	120	0	2	15	0	25	28	0	0	
11:30	11:45	0	4	3	0	8	62	110	1	122	3	19	0	20	34	0	0
11:45	12:00	0	1	3	0	14	62	91	0	67	9	23	0	25	48	1	0
12:00	12:15	2	4	4	0	9	64	117	0	12	3	7	0	29	34	1	0
12:15	12:30	1	1	5	0	15	44	99	0	84	7	14	0	25	42	0	1
12:30	12:45	3	2	6	0	7	66	110	0	14	8	23	0	16	44	10	1
12:45	1:00	0	0	0	0	12	65	101	0	83	7	13	1	10	26	0	4
Peak Period: 11:30AM-12:30 PM		3	10	15	0	46	232	417	1	285	22	63	0	99	158	2	1

Time Interval		Movements															Hourly Total
3:00pm - 5:00pm		1	2	3	3a	4	5	6	6a	7	8	9	9a	10	11	12	
3:00	3:15	3	3	7	0	16	89	126	0	55	7	25	0	17	45	5	0
3:15	3:30	2	4	3	0	14	67	129	0	45	4	10	0	7	30	4	0
3:30	3:45	1	2	5	0	6	91	103	0	85	7	37	0	42	68	6	0
3:45	4:00	0	0	4	0	13	86	112	1	67	1	23	0	9	35	2	0
4:00	4:15	0	1	2	0	13	86	114	0	74	8	26	0	39	40	7	0
4:15	4:30	0	6	2	0	11	74	113	0	66	9	11	0	36	49	5	0
4:30	4:45	2	6	5	0	14	78	123	0	57	11	17	0	32	46	6	0
4:45	5:00	0	1	7	0	7	84	92	0	73	8	20	0	11	42	3	0
Peak Period: 3:30PM-4:30 PM		1	9	13	0	43	337	442	1	292	25	97	0	126	192	20	0

Site: 6
 Survey Location: Cnr Princes H'way & Beach Rd, Batemans Bay
 Date: 18th March, 2010

Count Period

AM Period : 11:00 - 1:00pm
 PM Period : 3:00 - 5:00pm

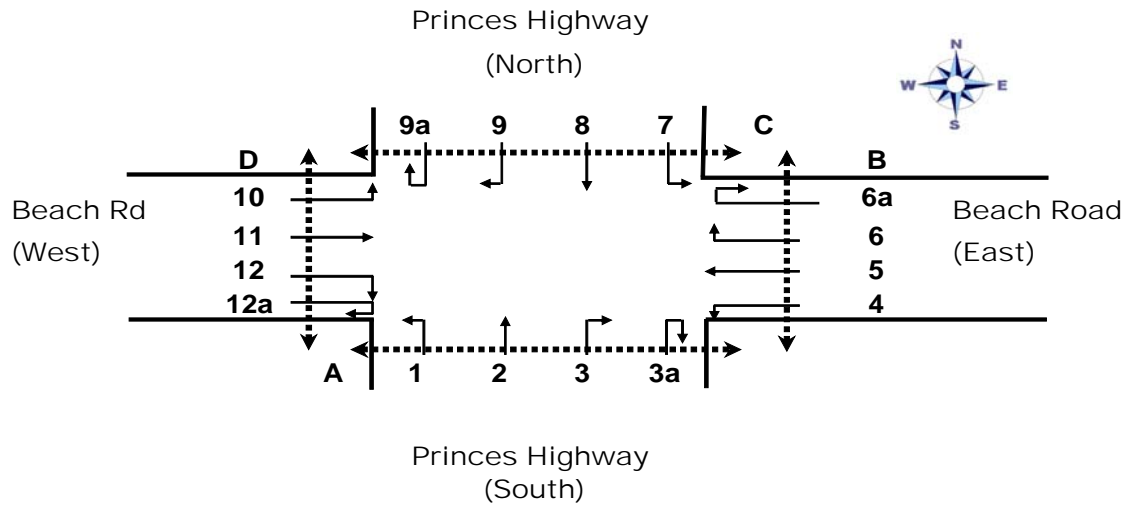

Time Interval		Movements														Pedestrian				Hourly Total		
		1	2	3	3a	4	5	6	6a	7	8	9	9a	10	11	12	12a	A	B		C	D
11:00	11:15	1	46	28	0	14	11	50	0	28	47	2	0	8	0	5	0	2	0	0	2	
11:15	11:30	3	78	34	0	15	13	52	0	15	52	1	0	4	5	1	0	0	2	2	0	
11:30	11:45	1	70	21	0	20	8	51	0	22	66	1	0	3	2	1	0	0	0	0	0	
11:45	12:00	2	46	22	0	20	13	62	0	27	54	3	0	2	6	4	0	5	0	2	0	1055
12:00	12:15	3	45	40	0	18	12	70	0	35	69	0	0	2	1	0	0	0	0	7	0	1113
12:15	12:30	3	64	43	0	14	6	48	0	38	59	1	0	2	7	1	0	0	0	1	0	1123
12:30	12:45	2	46	21	0	20	3	51	0	18	52	2	0	5	9	2	0	0	0	7	0	1095
12:45	1:00	0	70	29	0	20	22	61	0	22	70	4	1	1	5	2	0	0	0	5	1	1140
Peak Period: 12:00PM-1:00 PM		8	225	133	0	72	43	230	0	113	250	7	1	10	22	5	0	0	0	20	1	

Time Interval		Movements														Pedestrian				Hourly Total		
		1	2	3	3a	4	5	6	6a	7	8	9	9a	10	11	12	12a	A	B		C	D
3:00	3:15	2	64	24	1	19	5	88	0	40	42	0	0	4	2	0	0	0	0	2	0	
3:15	3:30	0	62	27	0	13	10	76	0	38	51	3	1	1	7	2	0	0	0	5	0	
3:30	3:45	4	78	34	0	26	14	95	1	30	55	5	0	9	16	2	0	0	0	5	0	
3:45	4:00	3	80	32	0	15	16	73	0	31	75	11	0	5	12	2	0	8	1	11	0	1338
4:00	4:15	4	73	19	0	9	18	71	0	23	66	10	1	12	15	6	0	0	6	17	0	1395
4:15	4:30	3	75	33	0	17	10	101	0	41	60	7	1	11	16	11	0	5	0	3	1	1494
4:30	4:45	5	80	28	0	12	14	78	0	36	59	7	2	13	14	7	0	2	4	2	0	1483
4:45	5:00	4	68	21	0	12	14	81	0	33	40	9	0	5	12	1	0	1	2	3	1	1415
Peak Period: 3:30PM-4:30 PM		14	306	118	0	67	58	340	1	125	256	33	2	37	59	21	0	13	7	36	1	

Site: 7
Survey Location: Cnr Orient St & Camp St, Batemans Bay
Date: 18th March, 2010

Count Period

AM Period : 11:00 - 1:00pm

PM Period : 3:00 - 5:00pm

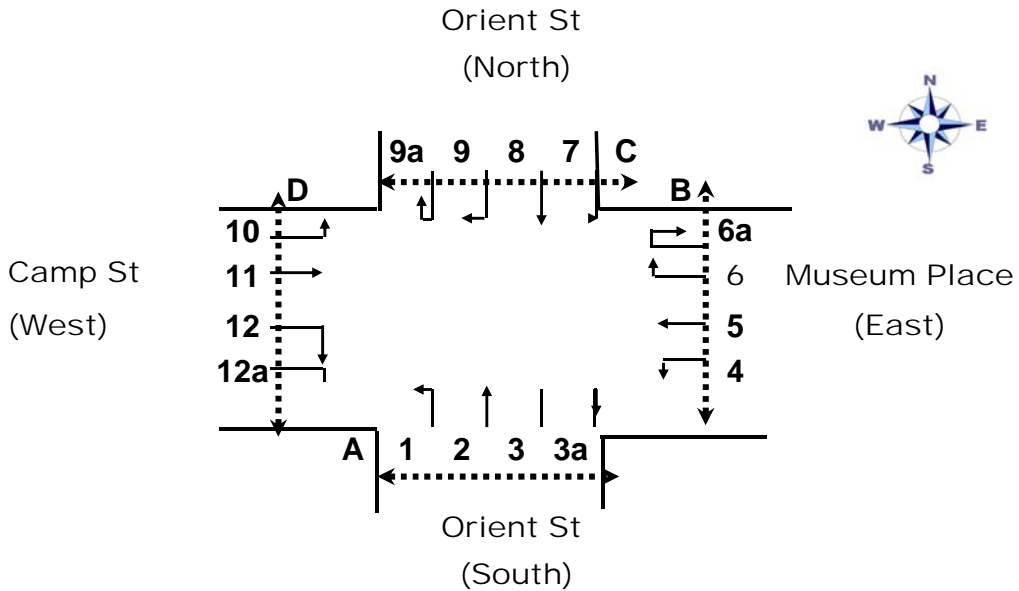

Time Interval 11.00am - 1.00am		Movements																Hourly Total
		1	2	3	3a	4	5	6	6a	7	8	9	9a	10	11	12	12a	
11:00	11:15	7	41	8	0	8	5	8	0	5	47	5	0	3	2	4	0	
11:15	11:30	4	37	14	0	0	4	3	0	3	36	4	0	7	0	11	0	
11:30	11:45	4	32	11	0	9	4	3	0	6	40	6	1	8	0	9	0	
11:45	12:00	5	29	18	0	5	1	0	0	5	42	5	1	0	0	8	0	518
12:00	12:15	4	17	8	0	1	5	3	0	4	29	9	2	3	0	9	0	469
12:15	12:30	7	28	33	0	6	2	1	0	2	36	5	4	9	1	7	0	487
12:30	12:45	24	30	10	0	1	1	0	0	2	26	5	1	7	1	4	0	466
12:45	1:00	6	28	6	0	2	0	1	0	5	34	3	0	2	0	2	0	436
Peak Period: 11:00AM-12:00 PM		20	139	51	0	22	14	14	0	19	165	20	2	18	2	32	0	

Time Interval 3:00pm - 5:00pm		Movements																Hourly Total
		1	2	3	3a	4	5	6	6a	7	8	9	9a	10	11	12	12a	
3:00	3:15	2	74	9	0	6	6	5	1	6	42	6	2	11	2	5	0	
3:15	3:30	7	59	18	0	5	4	5	0	9	41	12	1	5	5	14	0	
3:30	3:45	2	36	3	0	8	3	6	0	3	30	5	0	1	0	8	0	
3:45	4:00	1	31	24	0	4	5	2	0	4	31	7	0	0	1	7	0	584
4:00	4:15	5	29	19	0	2	6	6	0	6	28	6	3	7	7	13	0	544
4:15	4:30	6	18	15	0	0	2	0	0	3	16	11	2	5	1	3	0	441
4:30	4:45	8	29	14	0	4	3	0	0	5	21	8	0	10	2	5	0	445
4:45	5:00	1	21	5	0	0	3	1	0	6	19	5	0	8	4	7	0	408
Peak Period: 3:00PM-4:00 PM		12	200	54	0	23	18	18	1	22	144	30	3	17	8	34	0	

Site: 8
Survey Location: Cnr Old Princes H'way & South St, Batemans Bay
Date: 18th March, 2010

Count Period

AM Period : 11:00 - 1:00pm

PM Period : 3:00 - 5:00pm

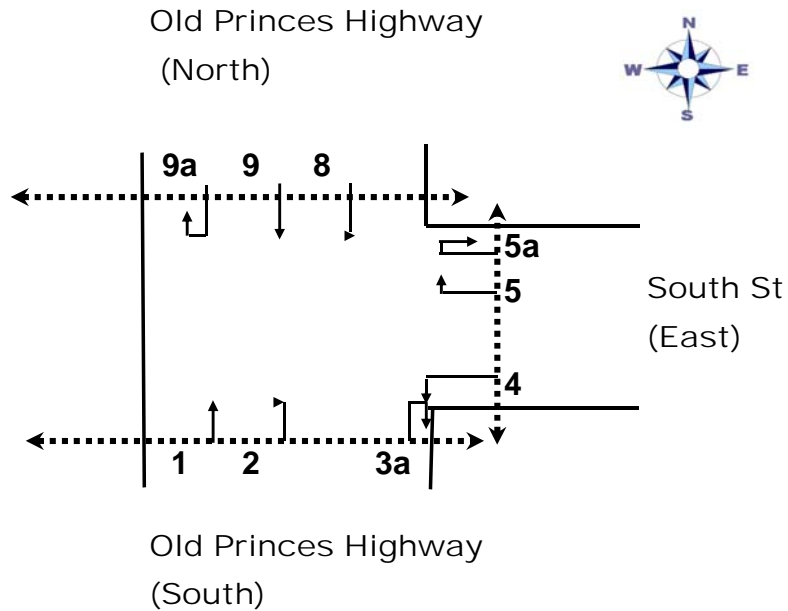

Time Interval 11.00am - 1.00am		Movements									Hourly Total
		1	2	3a	4	5	5a	8	9	9a	
11:00	11:15	27	16	0	29	17	0	19	35	0	
11:15	11:30	35	27	1	42	22	0	14	47	0	
11:30	11:45	36	33	0	24	21	0	23	40	0	
11:45	12:00	23	31	0	21	17	0	14	35	0	649
12:00	12:15	30	29	0	33	10	0	21	31	0	660
12:15	12:30	26	28	0	30	25	0	11	41	0	633
12:30	12:45	26	29	0	21	17	0	21	41	0	611
12:45	1:00	21	22	0	18	11	0	15	33	0	590
Peak Period: 11:15AM-12:15 PM		115	121	0	108	73	0	69	147	0	

Time Interval 3:00pm - 5:00pm		Movements									Hourly Total
		1	2	3a	4	5	5a	8	9	9a	
3:00	3:15	31	26	1	29	17	0	19	35	0	
3:15	3:30	28	34	0	42	22	0	14	47	0	
3:30	3:45	40	33	0	24	21	0	23	40	0	
3:45	4:00	38	41	0	21	17	0	14	35	0	692
4:00	4:15	25	42	0	33	10	0	21	31	0	696
4:15	4:30	32	48	0	30	25	0	11	41	0	696
4:30	4:45	31	47	0	21	17	0	21	41	0	693
4:45	5:00	21	38	0	18	11	1	15	33	0	664
Peak Period: 3:30PM-4:30 PM		135	164	0	108	73	0	69	147	0	

Site: 9
Survey Location: Cnr Princes H'way & Old Princes H'way, Batemans Bay
Date: 18th March, 2010

Count Period

AM Period : 11:00 - 1:00pm
PM Period : 3:00 - 5:00pm

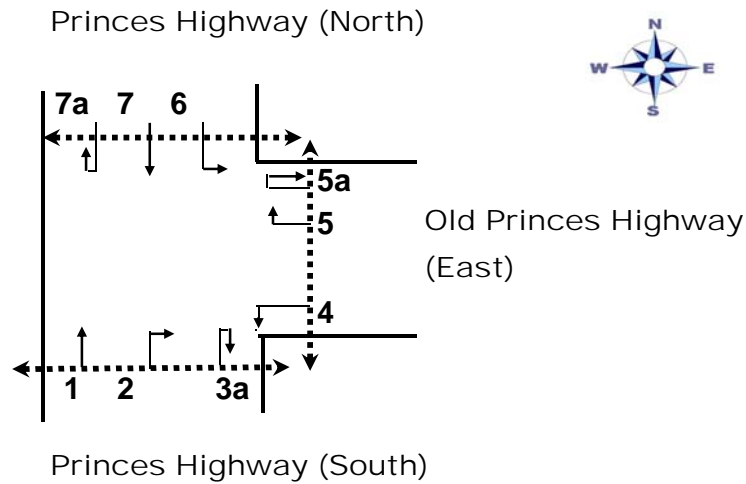

Time Interval		Movements									Hourly Total
		1	2	3a	4	5	5a	6	7	7a	
11:00am - 1:00pm											
11:00	11:15	42	37	0	41	3	0	14	43	0	
11:15	11:30	89	56	0	60	10	0	10	69	0	
11:30	11:45	70	69	0	55	6	0	12	69	0	
11:45	12:00	67	52	0	56	3	0	17	78	0	1028
12:00	12:15	79	71	0	52	2	0	16	84	0	1152
12:15	12:30	99	57	0	60	3	0	16	89	0	1182
12:30	12:45	66	49	0	49	4	0	16	68	0	1153
12:45	1:00	60	46	0	53	9	0	16	84	0	1148
Peak Period: 11:30AM-12:30PM		315	249	0	223	14	0	61	320	0	

Time Interval		Movements									Hourly Total
		1	2	3a	4	5	5a	6	7	7a	
3:00pm - 5:00pm											
3:00	3:15	63	54	0	67	8	0	11	69	0	
3:15	3:30	88	51	0	69	12	0	16	64	0	
3:30	3:45	115	69	0	74	9	0	14	87	0	
3:45	4:00	82	72	0	32	13	0	20	94	0	1253
4:00	4:15	102	76	0	59	9	0	10	93	0	1330
4:15	4:30	99	84	0	50	8	0	15	74	0	1360
4:30	4:45	71	36	0	27	13	0	14	78	0	1231
4:45	5:00	109	75	0	58	10	0	19	52	0	1241
Peak Period: 3:30PM-4:30PM		398	301	0	215	39	0	59	348	0	

Site: 10
Survey Location: Cnr Princes H'way & Hughes St, Batemans Bay
Date: 18th March, 2010

Count Period

AM Period : 11:00 - 1:00pm
PM Period : 3:00 - 5:00pm

Princes Highway (North)

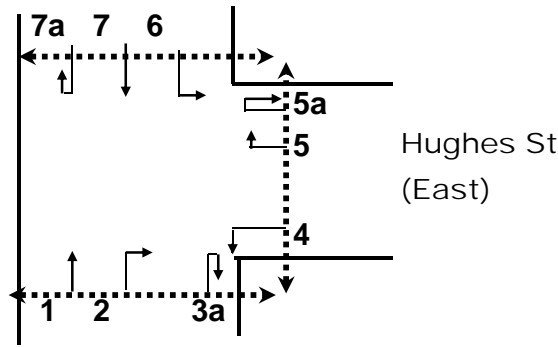

Princes Highway (South)

Time Interval		Movements									Hourly Total
11.00am - 1.00pm		1	2	3a	4	5	5a	6	7	7a	
11:00	11:15	48	22	0	14	11	0	18	71	1	
11:15	11:30	98	39	1	19	16	0	11	119	0	
11:30	11:45	83	19	0	4	15	0	10	97	1	
11:45	12:00	148	20	0	19	1	0	21	121	1	1048
12:00	12:15	106	6	0	15	14	0	25	106	1	1136
12:15	12:30	143	22	0	20	4	0	27	121	1	1171
12:30	12:45	116	7	0	20	10	0	17	105	1	1218
12:45	1:00	124	17	0	33	13	0	21	125	2	1222
Peak Period: 12:00PM-1:00PM		480	67	0	58	34	0	83	445	4	

Time Interval		Movements									Hourly Total
3:00pm - 5:00pm		1	2	3a	4	5	5a	6	7	7a	
3:00	3:15	93	16	1	26	12	0	14	122	2	
3:15	3:30	116	27	0	22	11	0	9	99	4	
3:30	3:45	152	21	0	15	18	0	23	143	2	
3:45	4:00	141	17	0	17	12	1	16	113	0	1265
4:00	4:15	136	26	0	19	26	0	32	123	3	1344
4:15	4:30	135	15	0	11	19	0	31	96	0	1363
4:30	4:45	135	17	0	15	18	0	14	94	1	1283
4:45	5:00	127	9	0	11	33	0	4	89	0	1239
Peak Period: 3:30PM-4:30PM		564	79	0	62	75	1	102	475	5	

Site: 11
Survey Location: Cnr Princes H'way & Cranbrook Rd, Batemans Bay
Date: 18th March, 2010

Count Period

AM Period : 11:00 - 1:00pm
PM Period : 3:00 - 5:00pm

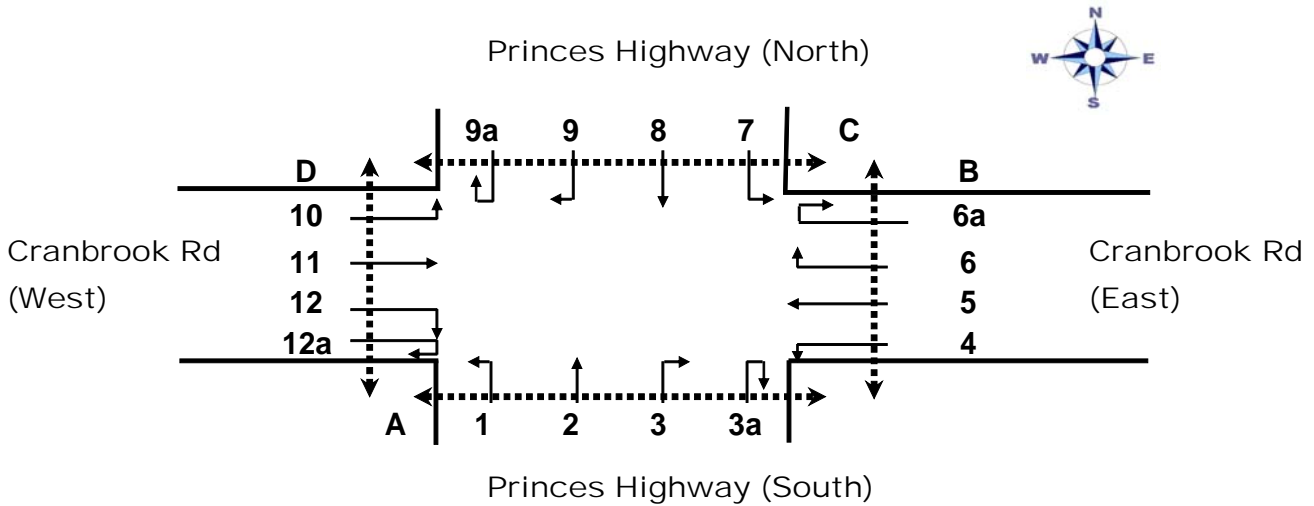

Time Interval		Movements															Hourly Total	
		1	2	3	3a	4	5	6	6a	7	8	9	9a	10	11	12		12a
11:00am - 1:00pm																		
11:00	11:15	10	44	0	0	0	0	0	0	0	29	44	2	35	0	9	0	
11:15	11:30	9	79	0	0	0	0	0	0	0	83	64	0	59	0	9	0	
11:30	11:45	14	75	0	0	0	0	0	0	0	68	38	1	57	0	8	0	
11:45	12:00	9	82	0	0	0	0	0	0	0	87	56	0	58	0	5	0	1034
12:00	12:15	11	64	0	0	0	1	0	0	1	80	39	0	53	0	10	0	1120
12:15	12:30	14	90	0	0	0	0	1	0	0	72	57	0	67	1	10	0	1129
12:30	12:45	8	65	0	0	0	0	0	0	2	79	50	0	45	1	11	0	1129
12:45	1:00	7	71	1	0	0	0	0	0	0	93	55	0	50	2	14	0	1125
Peak Period: 11:45AM-12:45 PM		42	301	0	0	0	1	1	0	3	318	202	0	223	2	36	0	

Time Interval		Movements															Hourly Total	
		1	2	3	3a	4	5	6	6a	7	8	9	9a	10	11	12		12a
3:00pm - 5:00pm																		
3:00	3:15	10	71	0	0	1	0	1	0	2	76	64	1	50	0	13	0	
3:15	3:30	14	73	0	0	0	0	0	0	2	69	48	0	60	0	10	0	
3:30	3:45	7	82	0	0	0	0	2	0	0	97	64	0	82	0	16	0	
3:45	4:00	6	79	0	0	0	0	0	0	0	76	47	0	62	0	11	0	1196
4:00	4:15	11	75	0	0	0	0	0	0	0	88	44	0	75	0	17	0	1217
4:15	4:30	12	67	0	0	0	0	1	0	1	78	45	0	81	0	13	0	1239
4:30	4:45	5	63	0	0	0	0	0	0	0	70	40	0	78	0	13	0	1158
4:45	5:00	10	75	1	0	0	0	2	0	1	70	28	0	48	0	4	0	1116
Peak Period: 3:00PM-4:00 PM		37	305	0	0	1	0	3	0	4	318	223	1	254	0	50	0	

Site: 12
Survey Location: Cnr South St, High St & Gregory St, Batemans Bay
Date: 18th March, 2010

Count Period

AM Period : 11:00 - 1:00pm
PM Period : 3:00 - 5:00pm

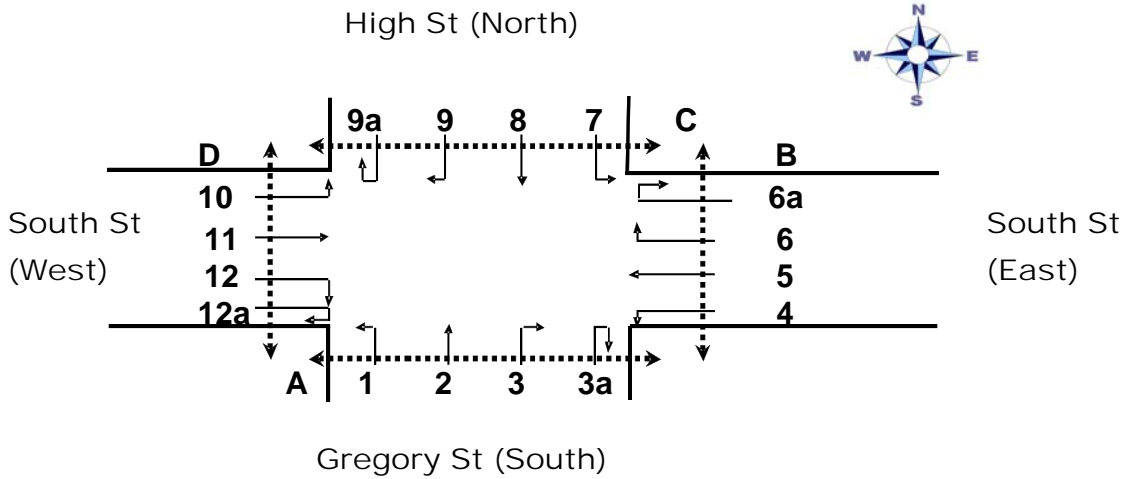

Time Interval		Movements															Hourly Total	
		1	2	3	3a	4	5	6	6a	7	8	9	9a	10	11	12		12a
11:00am - 1:00pm																		
11:00	11:15	11	1	3	0	9	33	1	0	1	2	2	0	2	26	5	0	
11:15	11:30	20	2	11	0	6	32	1	0	1	0	2	0	1	37	5	0	
11:30	11:45	16	2	13	0	7	26	3	0	3	1	2	0	2	57	7	0	
11:45	12:00	22	1	13	0	4	23	0	0	0	2	0	0	4	38	6	0	466
12:00	12:15	11	0	16	0	4	32	0	0	2	2	1	0	1	46	5	0	490
12:15	12:30	5	1	3	0	3	17	0	0	0	0	1	0	0	16	4	0	422
12:30	12:45	9	1	3	0	2	11	0	0	0	0	2	0	1	33	6	0	351
12:45	1:00	14	0	9	0	6	15	1	0	0	0	0	0	4	40	9	0	336
Peak Period: 11:15AM-12:15 PM		69	5	53	0	21	113	4	0	6	5	5	0	8	178	23	0	

Time Interval		Movements															Hourly Total	
		1	2	3	3a	4	5	6	6a	7	8	9	9a	10	11	12		12a
3:00pm - 5:00pm																		
3:00	3:15	14	1	9	0	9	34	0	0	0	0	1	0	1	45	6	0	
3:15	3:30	20	1	12	0	15	36	1	0	1	0	3	0	3	44	12	0	
3:30	3:45	12	0	2	0	2	23	0	0	0	0	1	0	4	29	7	0	
3:45	4:00	10	0	12	0	11	34	0	0	2	0	6	0	3	9	7	0	442
4:00	4:15	17	0	13	0	8	37	0	0	1	0	2	0	1	96	7	0	504
4:15	4:30	22	0	12	0	6	23	0	0	0	0	0	0	5	57	2	0	483
4:30	4:45	20	0	9	0	5	15	0	0	1	0	4	0	2	54	2	0	515
4:45	5:00	5	0	6	0	0	22	0	0	1	0	2	0	1	53	5	0	516
Peak Period: 4:00PM-5:00PM		64	0	40	0	19	97	0	0	3	0	8	0	9	260	16	0	

Site: 13
Survey Location: Beach Rd & Pacific St, Batemans Bay
Date: 18th March, 2010

Count Period

AM Period : 11:00 - 1:00pm

PM Period : 3:00 - 5:00pm

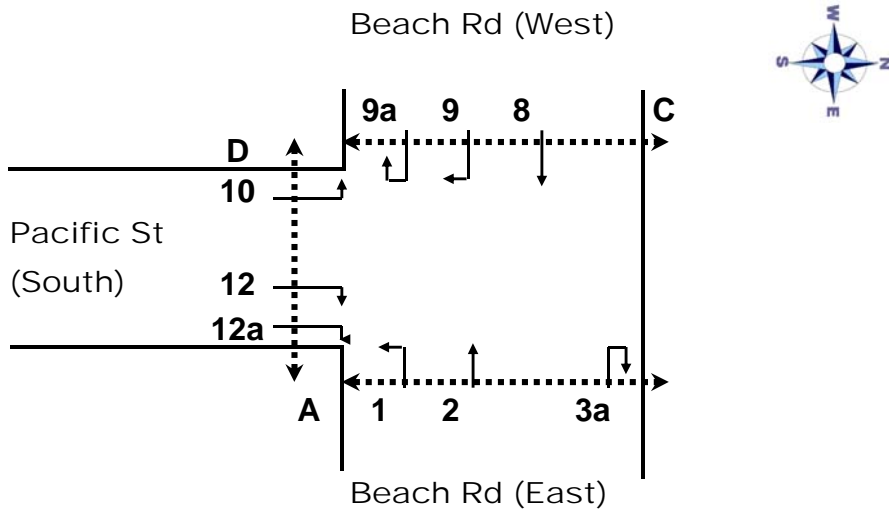

Time Interval 11.00am - 1.00am		Movements									Hourly Total
		1	2	3a	8	9	9a	10	12	12a	
11:00	11:15	28	178	0	177	18	3	18	6	0	
11:15	11:30	5	118	0	118	4	0	10	2	0	
11:30	11:45	4	144	0	157	8	0	15	9	0	
11:45	12:00	12	117	0	118	8	0	7	3	0	1287
12:00	12:15	5	123	0	148	4	0	9	5	0	1153
12:15	12:30	2	101	0	112	4	0	14	2	0	1131
12:30	12:45	7	153	0	271	9	0	10	5	0	1249
12:45	1:00	6	142	0	38	5	0	10	5	0	1190
Peak Period: 11:00AM-12:00 PM		49	557	0	570	38	3	50	20	0	

Time Interval 3:00pm - 5:00pm		Movements									Hourly Total
		1	2	3	8	9	9a	10	12	12a	
3:00	3:15	5	180	0	257	4	0	12	7	0	
3:15	3:30	11	224	0	229	17	0	12	6	0	
3:30	3:45	7	116	0	159	4	0	7	7	0	
3:45	4:00	10	138	0	228	7	0	15	5	0	1667
4:00	4:15	3	90	0	231	4	1	3	4	0	1538
4:15	4:30	10	138	0	106	4	0	15	4	0	1316
4:30	4:45	2	117	0	178	1	0	12	2	0	1328
4:45	5:00	5	90	0	147	4	0	7	1	0	1179
Peak Period: 3:00PM-4:00 PM		33	658	0	873	32	0	46	25	0	

Site: 14
Survey Location: Beach Rd & Bavarde Ave, Batemans Bay
Date: 18th March, 2010

Count Period

AM Period : 11:00 - 1:00pm
PM Period : 3:00 - 5:00pm

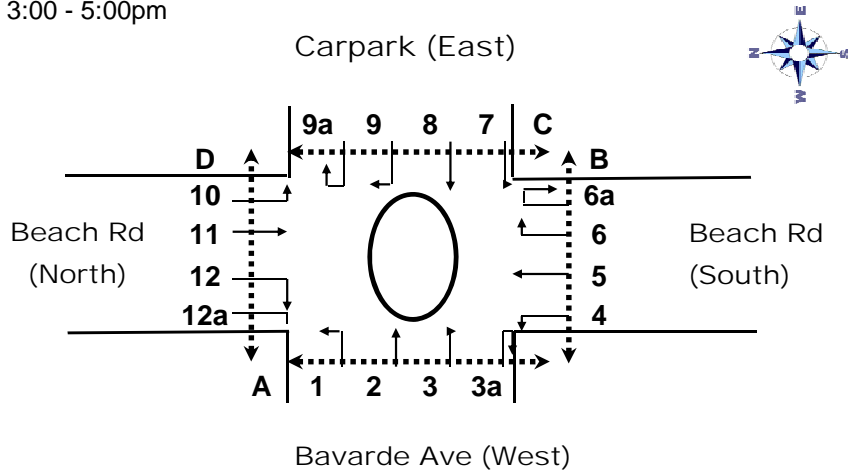

Time Interval		Movements															Hourly Total	
		1	2	3	3a	4	5	6	6a	7	8	9	9a	10	11	12		12a
11:00am - 1:00pm																		
11:00	11:15	3	1	35	0	22	102	1	0	0	0	4	0	3	103	8	1	
11:15	11:30	8	0	25	0	18	116	0	0	1	0	0	0	0	114	12	0	
11:30	11:45	5	2	43	2	26	128	2	1	0	1	1	0	2	123	6	2	
11:45	12:00	3	1	30	1	16	136	4	0	2	0	0	1	0	161	10	0	1286
12:00	12:15	6	0	44	3	26	115	2	2	1	0	3	0	4	154	11	0	1374
12:15	12:30	5	2	51	1	13	111	2	0	3	0	1	0	3	129	10	0	1411
12:30	12:45	7	2	28	1	13	112	5	0	3	1	2	0	0	106	11	1	1359
12:45	1:00	5	1	47	5	31	120	5	0	2	3	2	0	6	125	13	0	1359
Peak Period: 11:30PM-12:30PM		19	5	168	7	81	490	10	3	6	1	5	1	9	567	37	2	

Time Interval		Movements															Hourly Total	
		1	2	3	3a	4	5	6	6a	7	8	9	9a	10	11	12		12a
3:00pm - 5:00pm																		
3:00	3:15	4	0	42	1	53	146	0	2	2	0	1	0	0	180	10	0	
3:15	3:30	3	0	54	0	42	163	0	1	1	0	1	0	1	155	16	0	
3:30	3:45	4	0	47	1	39	143	1	1	1	0	0	0	2	124	9	0	
3:45	4:00	5	0	63	0	44	180	1	1	3	0	1	0	3	169	10	2	1732
4:00	4:15	7	1	50	1	36	216	2	0	0	0	2	0	4	146	14	0	1770
4:15	4:30	14	1	70	0	35	160	1	1	2	0	0	0	0	145	15	0	1777
4:30	4:45	5	1	86	0	23	114	1	3	2	0	0	0	0	180	12	1	1833
4:45	5:00	6	2	71	0	36	117	1	2	2	0	1	0	4	178	17	0	1788
Peak Period: 3:45PM-4:45PM		31	3	269	1	138	670	5	5	7	0	3	0	7	640	51	3	